

Rotary Blower Packages BB, CB, DB, EB, FB Series

With the world-renowned OMEGA PROFILE 

Air delivery 1.5 to 74 m³/min – Pressure up to 1000 mbar, Vacuum to 500 mbar

Intelligence
inside



COMPACT blowers

Innovative package concept

KAESER COMPACT blowers are designed to incur minimal operating and maintenance costs and to ensure maximum reliability. Furthermore, blowers equipped with an integrated control system and star-delta starter, or frequency converter (for flexible speed control), significantly reduce the amount of work required for planning, installation, certification, documentation and commissioning.

Integrated engineering

COMPACT series rotary blower packages are delivered complete with sound enclosure and integrated electrical equipment (optionally available as star-delta starter or variable speed control). All electrical equipment is sized according to required performance data and is wired and programmed for EMC compatibility as per applicable regulations.

Connectivity and safety

Using numerous sensors, the internal SIGMA CONTROL 2 monitors and controls all parameters essential to reliable and efficient blower system operation. Available remote monitoring and control further enhance blower availability. Versatile communication modules also enable SIGMA CONTROL 2 equipped blower packages to connect to master control systems, such as the SIGMA AIR MANAGER, and / or other centralised control systems.

Durability and efficiency

As with all KAESER products, COMPACT series blowers are designed and constructed with maximum efficiency, reliability and durability in mind. Together with their minimal maintenance and service requirement, these versatile blowers ensure lowest possible life cycle costs.

Components for blower stations

No matter whether for blower air or compressed air, the same rule applies: The air system should be considered as a whole. No one understands this better than KAESER KOMPRESSOREN, which is why we offer specifically tailored air supply solutions for every need. Systems and equipment include blower stations, master control systems, air treatment and piping which work seamlessly together to ensure maximum efficiency and reliability.

Industrial PC technology

The SIGMA CONTROL 2 ensures efficient blower control and system monitoring. The large display and RFID reader provide easy communication and maximum security. Multiple interfaces offer exceptional flexibility, whilst the SD card slot makes updates quick and easy.



The all-in-one system



Image: BBC OFC series with SIGMA CONTROL 2 controller and integrated frequency converter

COMPACT blowers

Meticulous design and manufacture

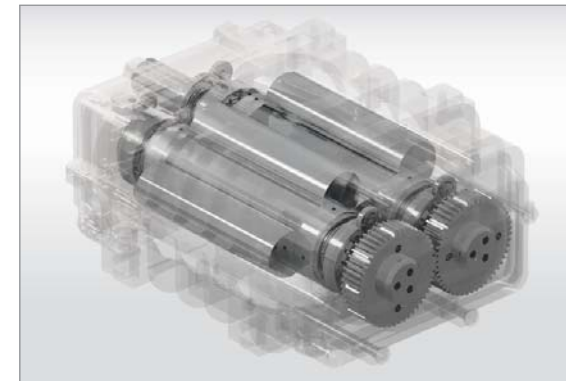

Durable OMEGA blower block

For pressures up to 1000 mbar(g), discharge temperatures up to 160 °C, wide control range with frequency controlled operation, Q 2.5 rotor balancing for quieter operation, extended service life and minimal maintenance requirement.



Generously sized bearings

Heavy-duty cylinder roller bearings completely absorb the continuously changing radial gas-forces that are exerted on the cylinders. As a result, they avoid the springing effect of self-aligning bearings and last up to ten times longer with the same loading.



Precision machining

High precision 5f 21 quality straight-cut timing gears have minimal flank clearance and a play major role in contributing to the block's outstanding volumetric efficiency. As the straight-cut gearing is not subjected to continuously changing radial gas-forces, heavy duty cylinder roller bearings can be used.

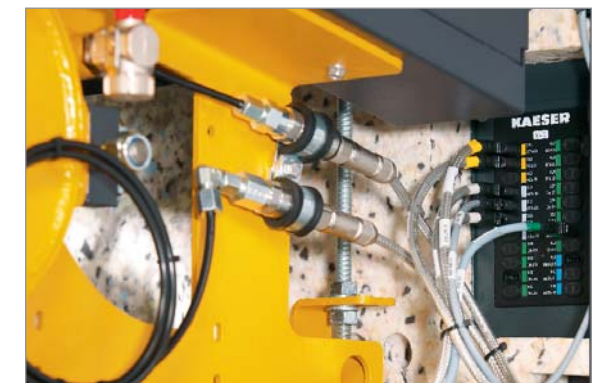

Comprehensive sensors

A wide range of sensors and switches for monitoring pressure, temperature, speed, oil level and filters ensures dependable blower operation and enables remote monitoring and visualisation of operational status.

COMPACT blowers

Variable speed control at its best

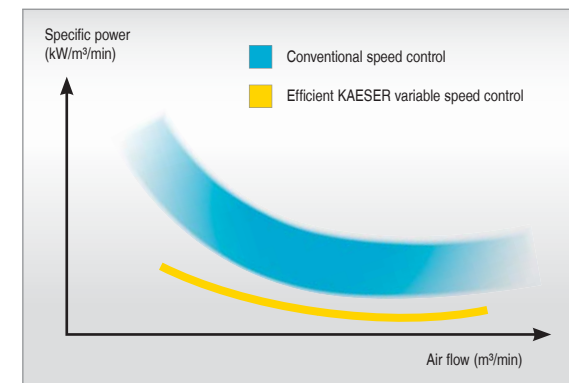

Wide control range

Optimised matching of the blower block, drive motor and variable speed controller allows a wide control range to ensure maximum efficiency in multi-unit operation without undershooting air demand or delivering fluctuating excess air supply.



Always in control

No matter whether the blower system is equipped with star-delta starter or variable speed control, users can choose from numerous operating modes. This is particularly relevant if several units are to be incorporated into a blower station.



High-quality control cabinet

The control cabinet houses only precisely matched electrical and electronic components from renowned German manufacturers. When it comes to electromagnetic compatibility (EMC), all cables are safely shielded where required.



Complete system EMC certified

The electromagnetic compatibility (EMC) of the components and the whole machine have been tested and approved in conformity with applicable directives.

The COMPACT blower package range from KAESER



Clear display instrumentation

Blowers equipped with a sound enclosure but no integrated electrical components feature a pressure gauge and filter maintenance indicator (pressure operation) or filter differential pressure switch (vacuum operation). A tele-thermometer with adjustable limit switch is also optionally available for block discharge temperature monitoring.

SIGMA CONTROL 2

The SIGMA CONTROL 2 ensures efficient blower control and system monitoring. The large display and RFID reader provide easy communication and maximum security. Variable interfaces offer excellent flexibility for data bus connection, whilst the SD card slot makes updates quick and simple.

SIGMA AIR MANAGER 4.0

This advanced master control system can co-ordinate operation of 4, 8 or 16 blowers with maximum energy efficiency and also enables seamless documentation of all operational parameters.



Image: Station with DBC blowers and SIGMA AIR MANAGER in a water treatment application

Equipment

Blower block

Robust and durable, energy-efficient OMEGA PROFILE rotors, wide control range.

Drive motor

Proprietary brand, premium efficiency IE3 motor, three PTC thermistors as standard; variable speed drive models co-ordinated with OFC frequency converter. Maintenance is fast and efficient thanks to easy access central lubrication points for motors with re-lubricatable motor bearings.

Sound insulation

The system's blower and motor cooling air is drawn in from outside the sound enclosure from the cooler ambient surroundings. Effective sound-proofing provided by thick-walled lining with dense foam and damping louvers over intake and exhaust openings.

Wide-band absorption silencer minimises process air pulsation downstream from the blower block. This results in low residual pulsation and therefore minimal sound transfer to downstream piping.

Power transmission

Highly effective automatic belt-tensioning system for consistent transmission performance, V-belt safety grille, belt-tensioning mechanism also acts as a motor lifting device when changing the belt.

Controller

SIGMA CONTROL 2 with blower-specific software, large display and RFID reader ensure effective communication and enhanced security. Outstanding flexibility and easy connection to centralised control systems via variable interfaces, SD card reader for quick and easy updates as well as recording of operational data.

ACA aftercooler

Highly efficient ACA aftercoolers specially developed by KAESER for operation with rotary blowers. With minimal pressure loss, they reduce blower air temperature to a maximum of 10 °C above ambient and require no cooling water. Electrical connection can be implemented directly in the blower control cabinet.

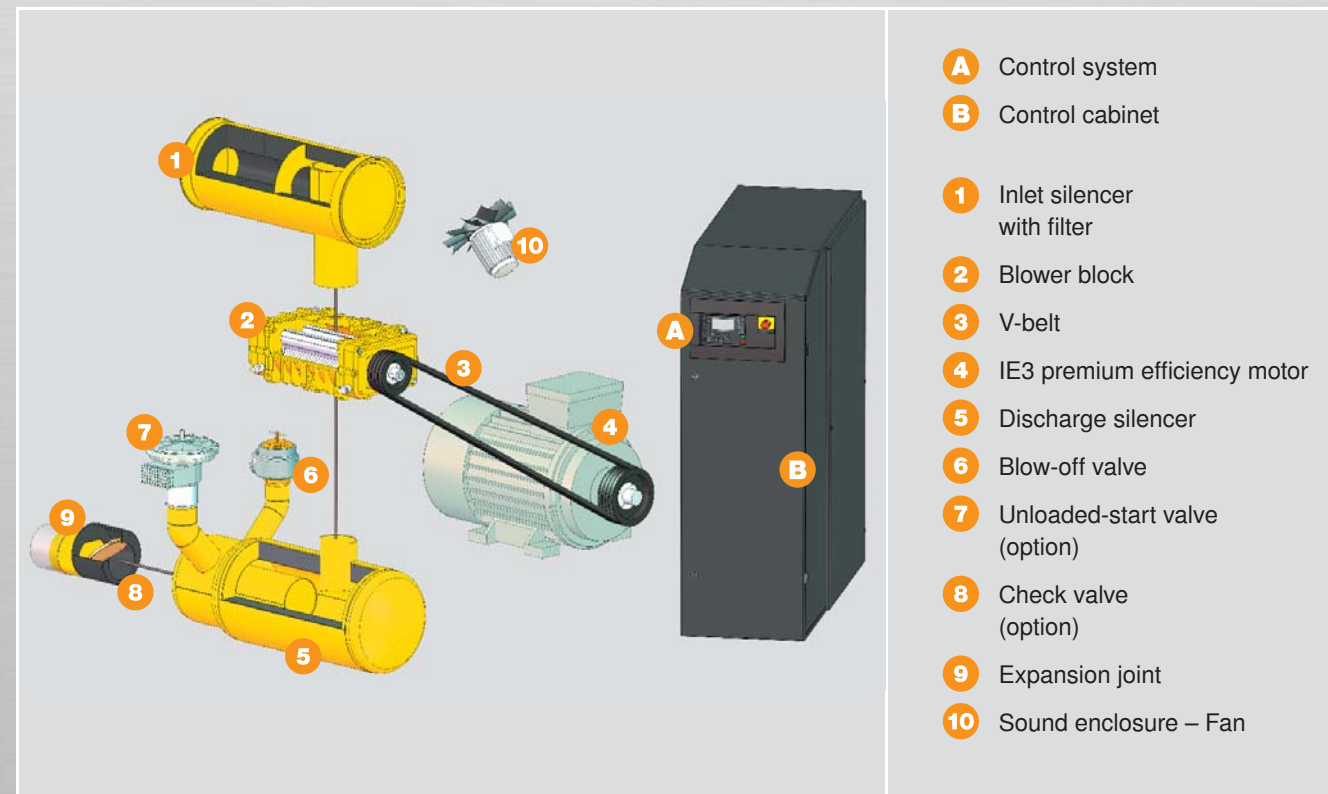

Image: ACA aftercooler

Technical specifications

Model	Gauge pressure		Vacuum		Max. rated motor power kW	Pipe connection DN	Dimensions with control cabinet and sound enclosure W x D x H mm	Max. mass kg
	Max. pressure differential mbar (g)	Max. flow rate * m³/min	Max. pressure differential mbar (vac)	Max. suction rate m³/min				
BB 69 C	1000	5.9	500	5.9	15	65	1210 x 960 x 1200	455
BB 89 C	1000	8.2	500	8.3	15	65	1210 x 960 x 1200	461
CB 111 C	800	8.8	400	8.9	18.5	80	1530 x 1150 x 1290	583
CB 131 C	1000	12.3	500	12.4	30	80	1530 x 1150 x 1290	642
DB 166 C	1000	15.6	500	15.7	37	100	1530 x 1150 x 1290	802
DB 236 C	1000	22.1	500	22.3	45	100	1530 x 1150 x 1290	822
EB 291 C	1000	28.6	500	28.8	75	150	1935 x 1600 x 1700	1561
EB 421 C	1000	40.1	500	40.4	75	150	1935 x 1600 x 1700	1606
FB 441 C	1000	41.3	500	41.6	90	200	2230 x 1920 x 1910	2326
FB 621 C	1000	58.5	500	58.9	132	200	2230 x 1920 x 1910	2839
FB 791 C	800	71.3	500	71.8	110	250	2230 x 1920 x 2090	2541

General design



Detailed customer-specific planning

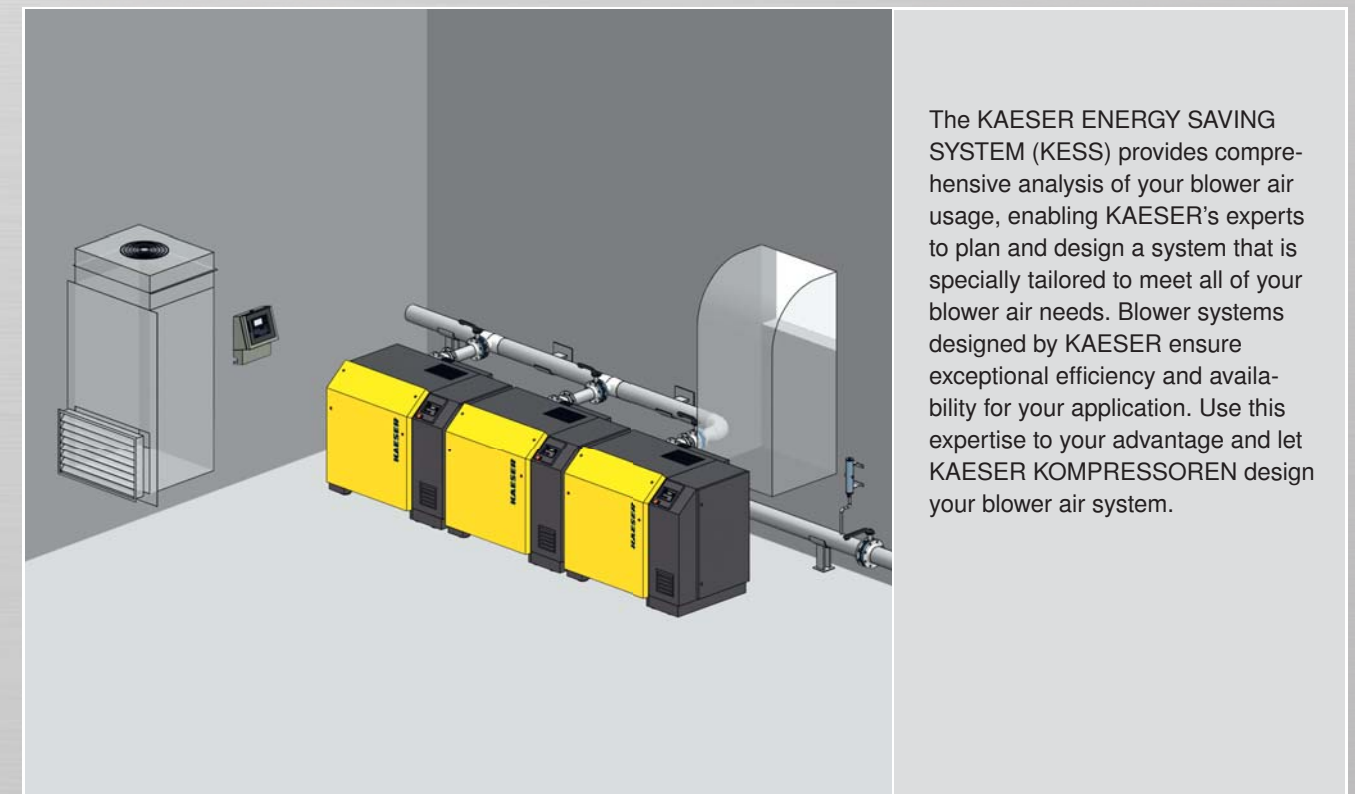

Views

Front view	Rear view	Left view	Right view	3-D view
------------	-----------	-----------	------------	----------

BB 69/89 C series – Without control cabinet

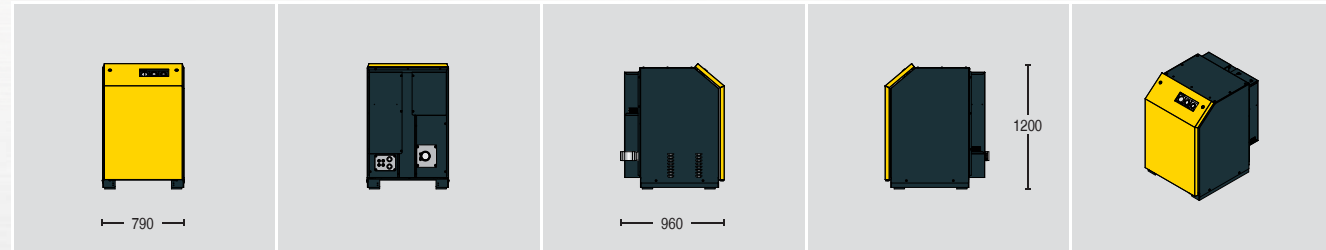

BB 69/89 C series – With control cabinet

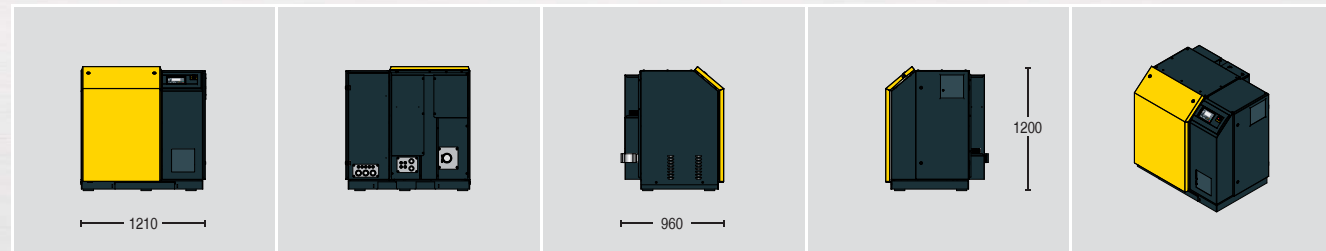

CB 111/131 C series – Without control cabinet

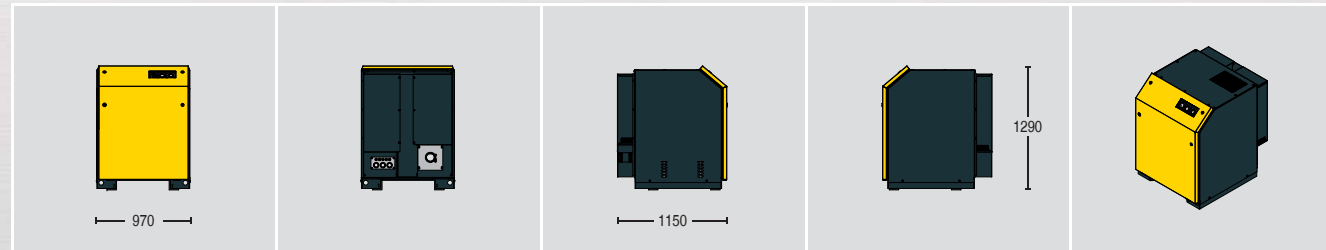

CB 111/131 C series – With control cabinet

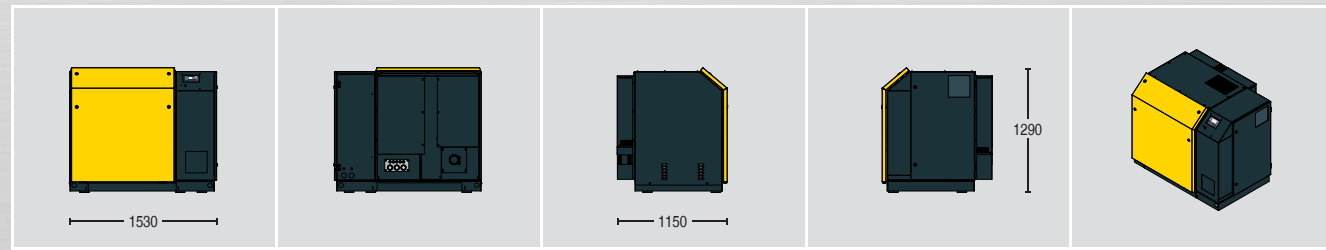

DB 166/236 C series – Without control cabinet

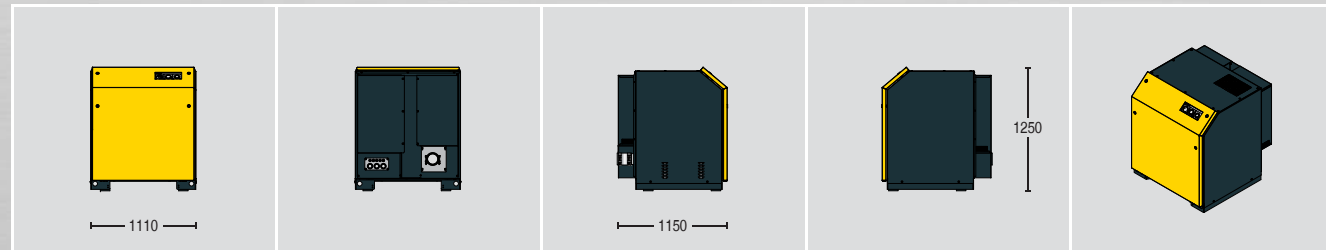

DB 166/236 C series – With control cabinet

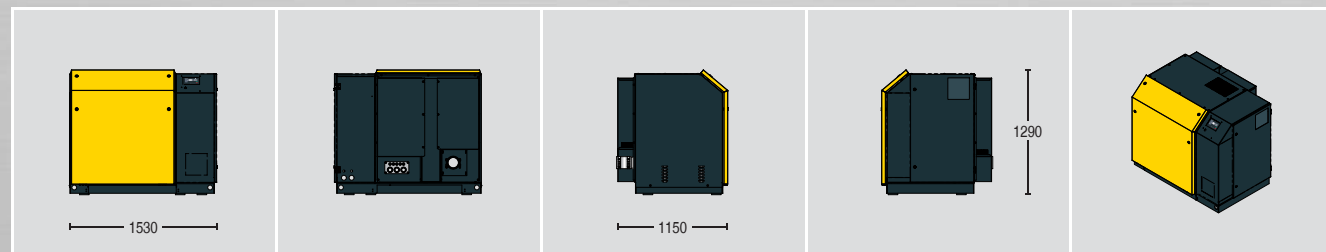

Front view	Rear view	Left view	Right view	3-D view
------------	-----------	-----------	------------	----------

EB 291/421 C series – Without control cabinet

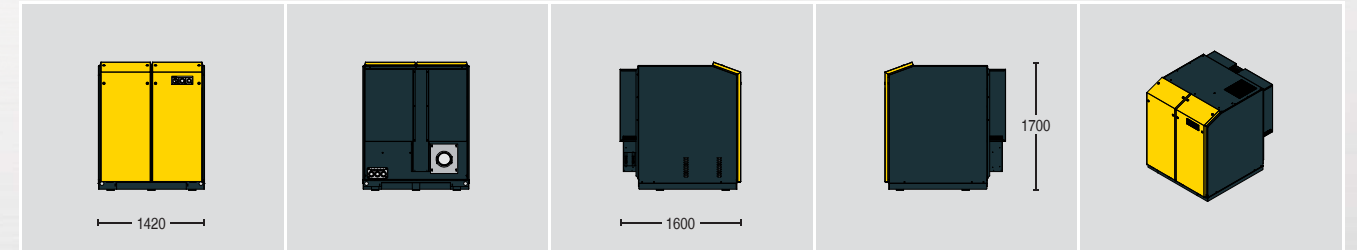

EB 291/421 C series – With control cabinet

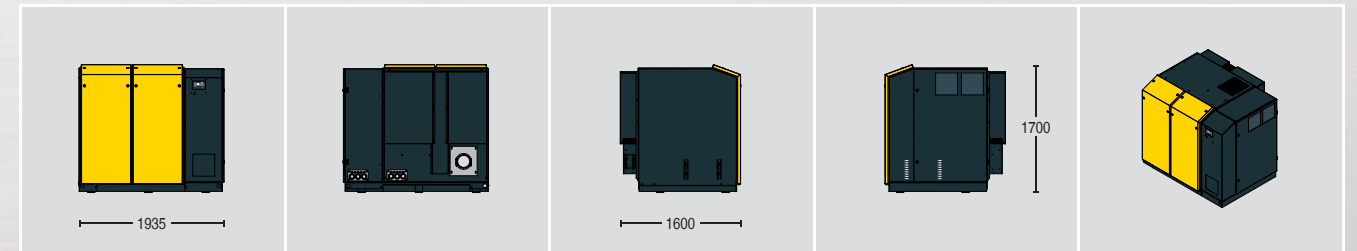

FB 441/621 C series – Without control cabinet

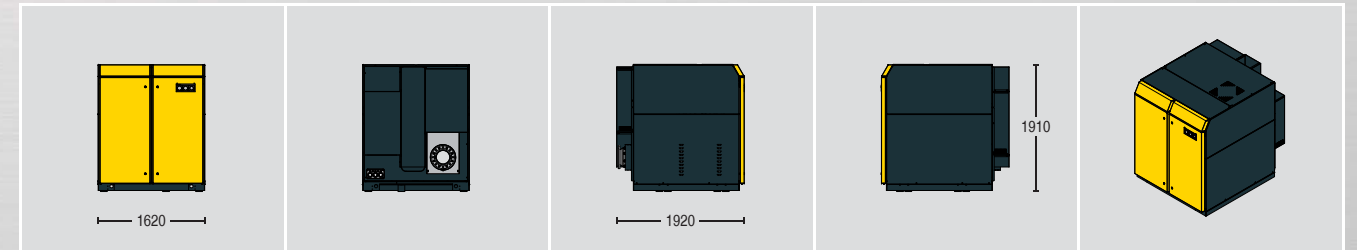

FB 441/621 C series – With control cabinet

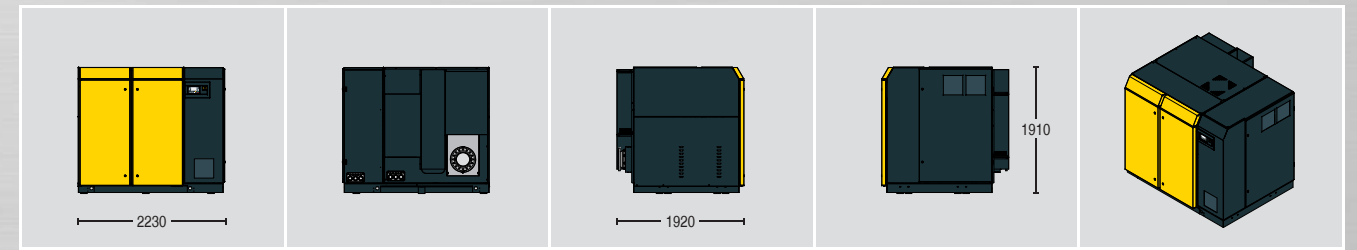

FB 791 C series – Without control cabinet

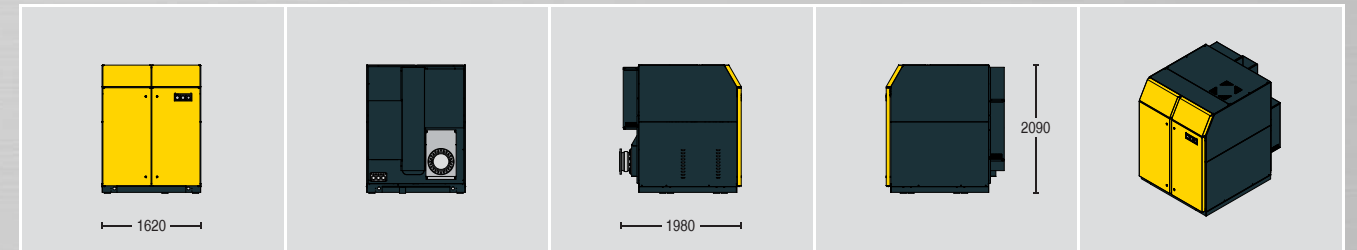

FB 791 C series – With control cabinet

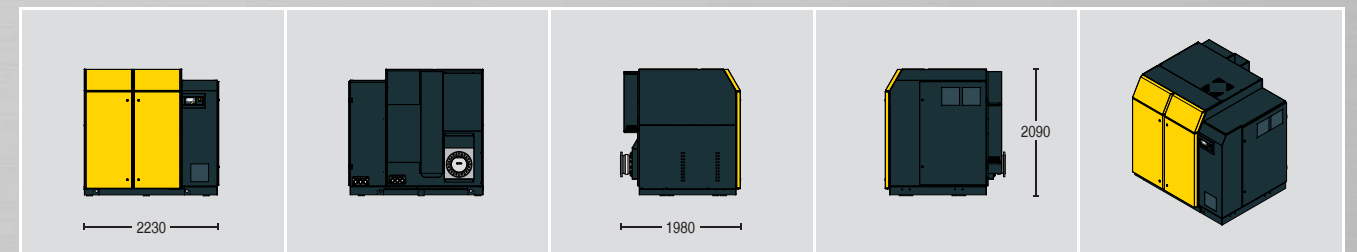

KAESER – The world is our home

As one of the world's largest compressed air systems providers and compressor manufacturers, KAESER KOMPRESSOREN is represented throughout the world by a comprehensive network of branches, subsidiary companies and authorised partners in over 100 countries.

With innovative products and services, KAESER KOMPRESSOREN's experienced consultants and engineers help customers to enhance their competitive edge by working in close partnership to develop progressive system concepts that continuously push the boundaries of performance and compressed air efficiency. Moreover, the decades of knowledge and expertise from this industry-leading system provider are made available to each and every customer via the KAESER group's global computer network.

These advantages, coupled with KAESER's worldwide service organisation, ensure that all products operate at the peak of their performance at all times and provide maximum availability.

